

8

7

6

5



4



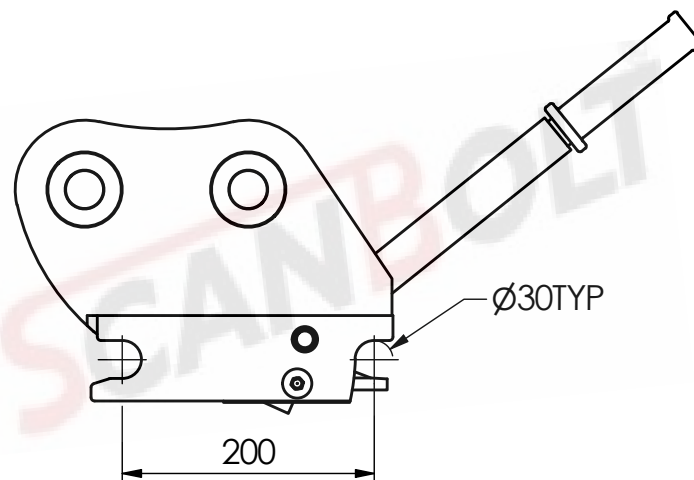
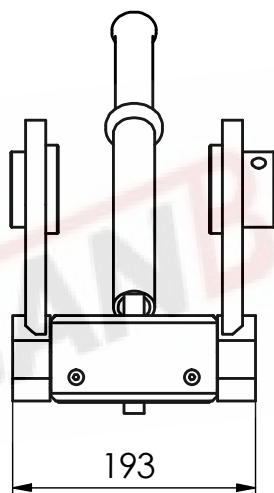
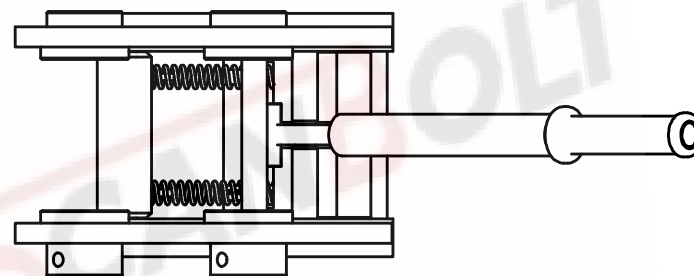

3

2

1



MATERIAL SPECIFICATION

	ST52.3
	EN8D
	HB 400
	HB 450
	CASTALLOY STEEL

SCANBOLT®

DESCRIPTION	MECHANICAL HITCH
TYPE	S30-195X200mm
MACHINE CLASS	0.8-2.0 TON
WEIGHT	12 KG

8

7

6

5



4

3

2

1